

CONDOR

Automatic Key Cutting Machine

XC-MINI

User Manual



TABLE OF CONTENTS

1) SAFETY PRECAUTIONS AND WARNINGS -----	02
2) GENERAL INFORMATION -----	03
3) PRODUCT PACKAGING CHECKLIST -----	04
4) OVERVIEW	
4.1 SCHEMATIC -----	06
4.2 CHARACTERISTICS -----	07
4.3 SPECIFICATIONS -----	07
5) MACHINE INSTALLATION AND PREPARATION	
5.1 INSTALLING THE CUTTER -----	08
5.2 REMOVING THE CUTTER -----	09
5.3 CLAMP INSTALLATION -----	10
5.4 CLAMP SAMPLES -----	11
6) OPERATING INSTRUCTIONS	
6.1 HEIGHT LEVEL ADJUSTMENT -----	12
6.2 CLAMP CALIBRATION -----	14
6.3 CUTTING CALIBRATION -----	16
6.4 HOW TO USE KEY DATABASE -----	18
6.5 HOW TO USE KEY DUPLICATION -----	21
6.6 HOW TO USE CUT BY BITTING -----	24
6.7 HOW TO USE FIND BITTING -----	28
7 ONLINE UPDATE -----	31

1 . Safety Precautions and Warnings

To prevent personal injury or machine damage, users should carefully observe the instructions provided by this operation manual and adopt the following safety precautions:

- Always operate the machine under the safe condition
- Wear safety glasses that meets ANSI standards
- Keep protective shield closed when machine is operating
- Keep clothing, hair, hands, tools, test equipment, etc. away from all moving parts.
- Do NOT leave the machine while it is operating
- Do not use damaged or loosen power cord and power outlet
- Unplug the power cord when not in use for a long time
- Do not place the machine in any wet, oily, dusty area
- Do not place any tool or container on the machine
- Place the machine on a horizontal surface, which should be firm enough to carry the weight of the machine..
- Keep the machine clean and dry
- Shut down the machine immediately when any exception occurs

2 . General Information

Thank you for choosing CONDOR XC-Mini Automatic Key Cutting Machine.

This manual serves as a guide for users of CONDOR XC-Mini Automatic Key Cutting Machine. Please read it carefully before use. It is crucially important if you wish to operate the machine safely and efficiently.

-- If exterior color of the machine changes, the final Color in kind prevail

-- Under the usage of instruction sheet, The warranty time is three years











-- Even if within the warranty period, if the following occurs, certain maintenance costs will not be free:

- The product malfunction caused by Not in accordance with the user manual operation
- The malfunction and damage caused by unauthorized repairs and alteration.
- The product malfunction caused by the fall, crash and the improperly voltage
- Damage due to force majeure
- Long time use in harsh places or vehicles, ships equipped with caused by failure or damage
- The working condition caused pollution and old, will not replace the shell

All rights reserved. No part of this publication may be reproduced, stored in a retrieval system, or transmitted, in any form, or by any means (mechanical, electronic, photocopying, recording, or others), without permission of XHorse. Due to continuous product improvement, the information contained in this manual is subject to change without notice.

3. Product Packaging Checklist

The whole package covers the following items, if missing, please contact your dealer. There are four kinds of power cord, we only supply one of them based on the actual demand of different countries.

Name	Image	Quantity	Description
2.5mmCutter		1	Cutting tool ($\text{Ø}2.5 \times \text{Ø}6 \times 40\text{L}$)
1.5mmCutter		1	Cutting tool ($\text{Ø}1.5 \times \text{Ø}6 \times 40\text{L}$)
1.0mm Probe		2	Detection tool ($\text{Ø}1.0 \times \text{Ø}6 \times 40\text{L}$)
2mm Allen wrench		1	Tool for tracer point installation
Power cord (1.5m) (optional)		1	Connect to power (Chinese Standard)
Power cord (1.5m) (optional)		1	Connect to power (British Standard)
Power cord (1.5m) (optional)		1	Connect to power (American Standard)
Power cord (1.5m) (optional)		1	Connect to power (European standard)
USB cable (2.0m)		1	Connect machine to PC
Brush		1	Tool for cleaning the machine

M1 Clamp		1	For Single/Double Sided Keys
M2 Clamp		1	For Channel-Track Keys
M3 Clamp		1	For Channel-Track Keys
KeyMachine body		1	Main body
Quality certificate		1	
Product Packaging Checklist		1	
User Manual		1	

Attention:

- Replace the cutter regularly to ensure the key cutting quality.
- Users should check the stepper motor belt regularly. If excessive wear and tear occur, please replace these parts to ensure the key cutting accuracy and the efficient operation of the machine
- Please use the 10A fuse.

4. Overview

4.1 Schematic



4.2 Characteristics

- Built-in Database
- Multi-languages Support
- 7" Capacitive Touch Screen
- 3-Axis Precision Ball Screw Transmission
- Cross Rail
- All Aluminum Machine Body
- Single machine with both Tracer/Cutter
- Standardly include three clamps M1/M2/M3
- Software supports online-update
- Support Sided/Track/Dimple/Tibbe keys*

*Some Dimple/Tibbe keys need optional clamps

4.3 Specifications

Input Voltage	90V--264VAC
Input Frequency	47~63Hz
Consume	200W
Packing Dimensions	L450×W450×H350mm
Machine Dimensions	L265×W362×H301mm
Display	1024×600
Spindle Speeds	9000rpm
USB	USB2.0
Working Temperature	0~50°C
Humidity	10~90%
Net Weight	18Kg
Gross Weight	22.9Kg

5. Installation

5.1 Installing the cutter

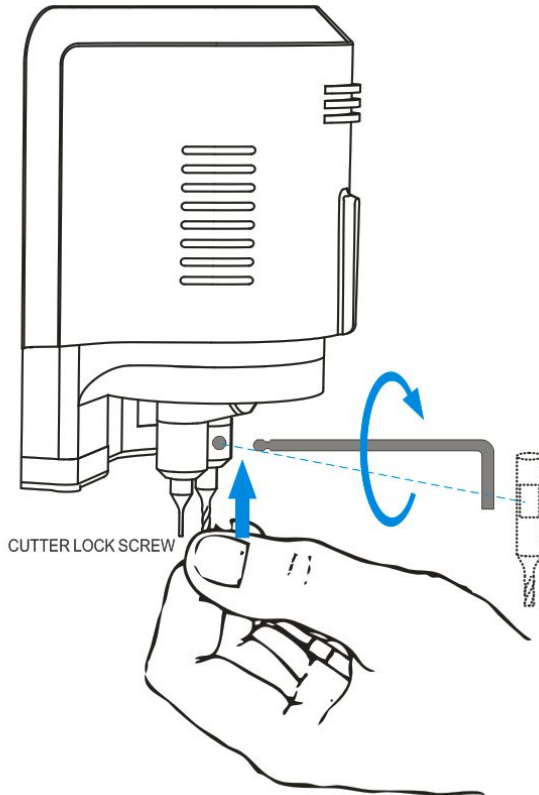

To Install the cutter

- 1) Put the cutter into the cutter hole and to the top limit position, ensure the section of cutter and clamp lateral parallel
- 2) Turn the CUTTER LOCK SCREW clockwise, till the cutter is tightened.

5.2 Removing the Cutter

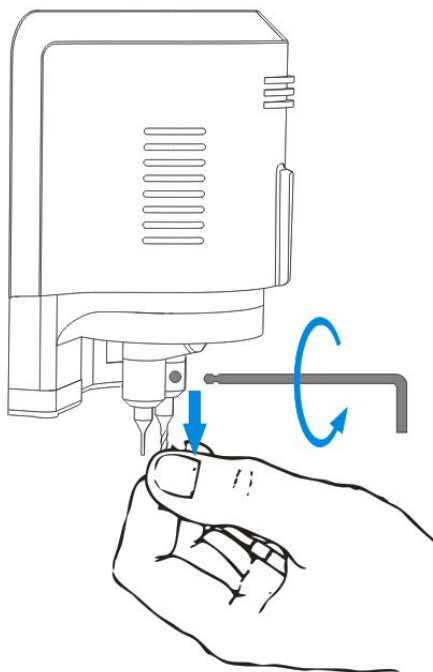

To Remove the Cutter

- 1) Hold the cutter lightly, Turn the CUTTER LOCK SCREW counterclockwise
- 2) after the cutter loosen, remove it

5.3 Clamp installation

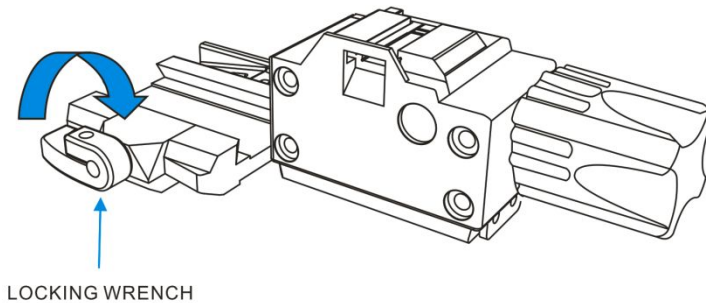

To Install the Clamp

- 1) Turn the LOCKING WRENCH counterclockwise on the left side to loosen.
- 2) Choose the clamp according to the key type, Push the clamp from the right side of the CLAMP CARRIAGE to limit position
- 3) Turn the LOCKING WRENCH clockwise to tighten the clamp

5.3 Clamp Samples



Clamp M1



Clamp M2



Clamp M3

6. Operating instructions

Please initial device before use

6.1 Height Level Adjustment



1) Enter the Main interface, Click on the Self Test

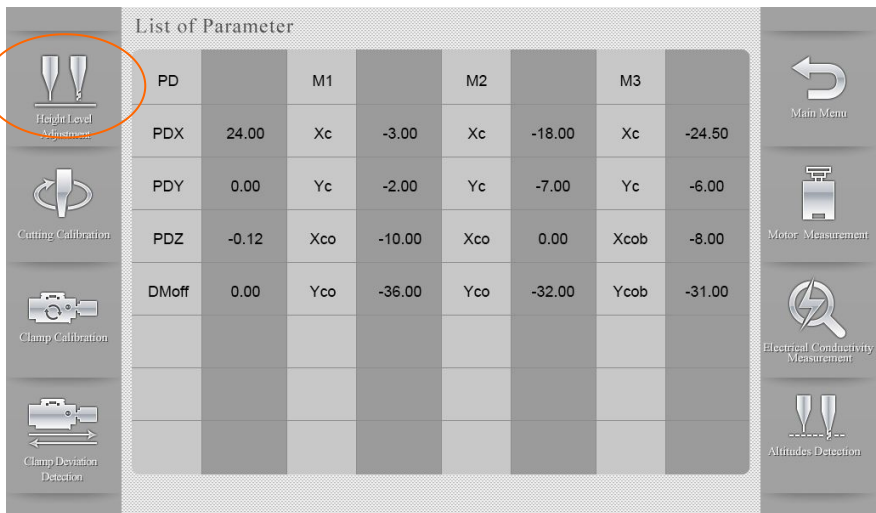

2) Click on Height Level Adjustment

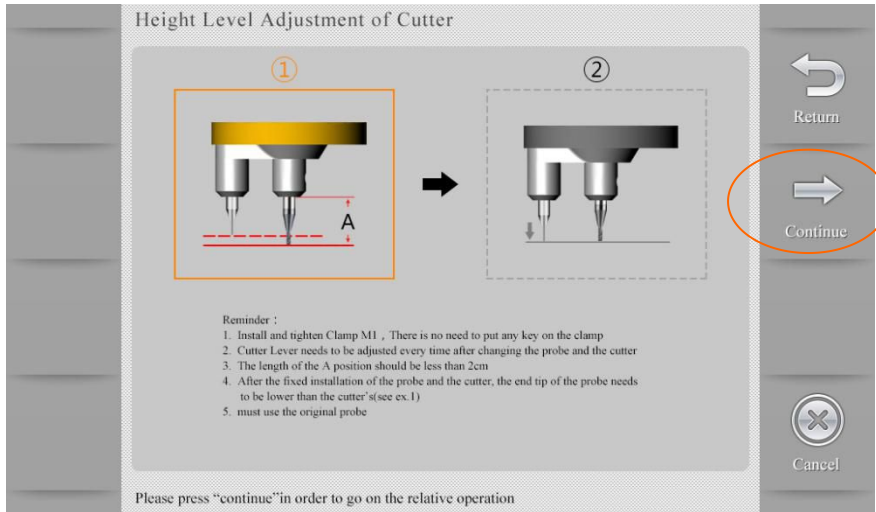

3) Follow the instructions on the screen, then click on the CONTINUE

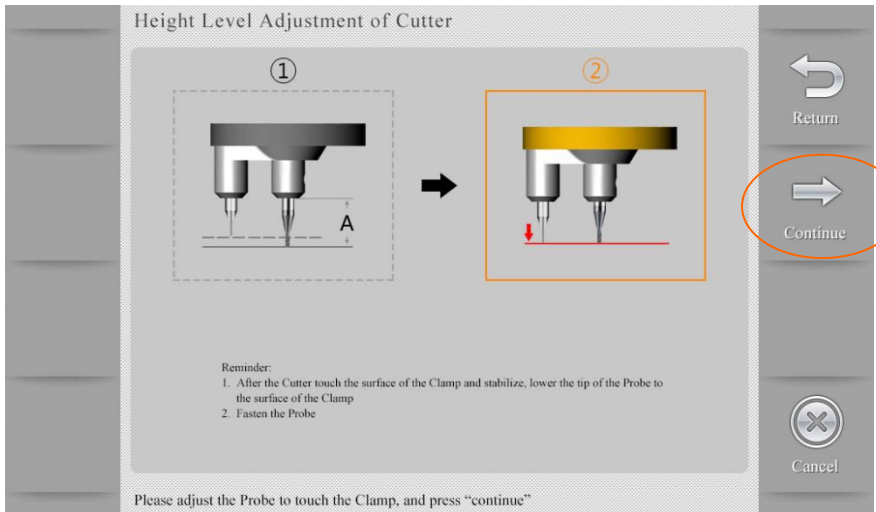

4) after the machine has stopped, follow the instructions on the screen till the tips of the probe and the cutter are on the same horizontal level. Then click on CONTINUE. The machine enters the Calibration Process.

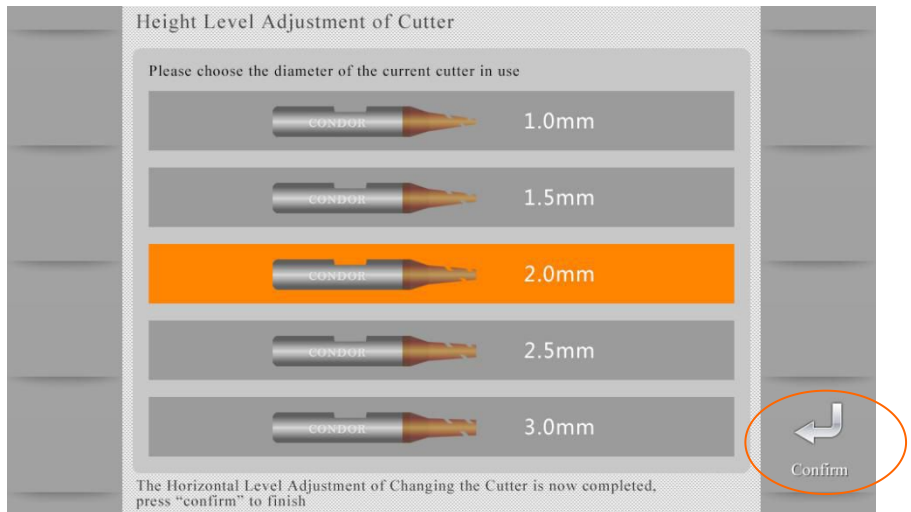

5) After the machine has stopped, select the diameter of the current cutter in use, then click on Confirm to finish

6.2 Clamp Calibration

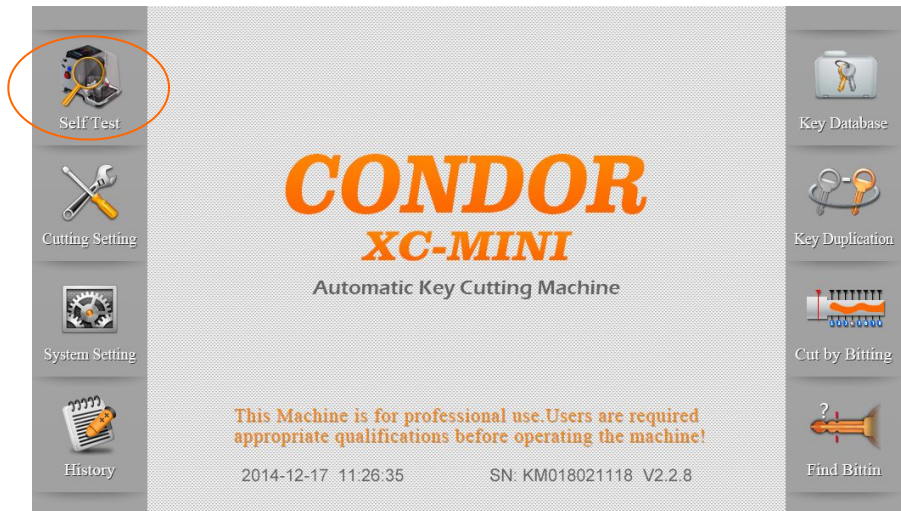

1) Enter the Main interface, Click on Self Test

List of Parameter

PD		M1		M2		M3	
PDX	24.00	Xc	-3.00	Xc	-18.00	Xc	-24.50
PDY	0.00	Yc	-2.00	Yc	-7.00	Yc	-6.00
PDZ	-0.12	Xco	-10.00	Xco	0.00	Xcob	-8.00
DMoff	0.00	Yco	-36.00	Yco	-32.00	Ycob	-31.00

Height Level Adjustment

Cutting Calibration

Clamp Calibration

Clamp Deviation Detection

Main Menu

Motor Measurement

Electrical Conductivity Measurement

Altitudes Detection

2) Enter Self Test interface, Click on Clamp Calibration

Clamp Calibration

M1

M1 Single/Double Sided Clamp Calibration

M2

M2 Channel-Track Clamp Calibration

M3

M3 Channel-Track Clamp Calibration

Please Choose the Clamp that needs Calibration

Return

3) Enter Clamp Calibration, Click on M1 button

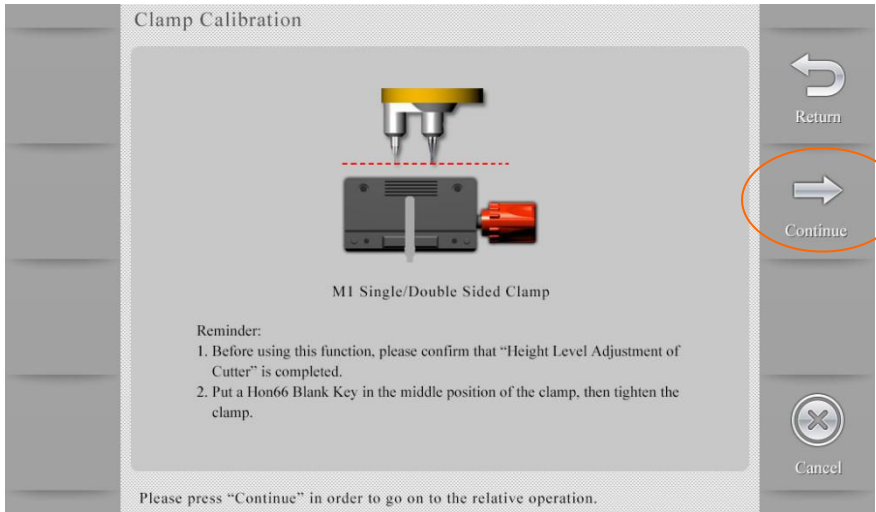

- 4) Follow the steps on the screen, then click on CONTINUE
- 5) Same methods to M2, M3 Clamp Calibration, do all steps follow the screen

6.3 Cutting Calibration

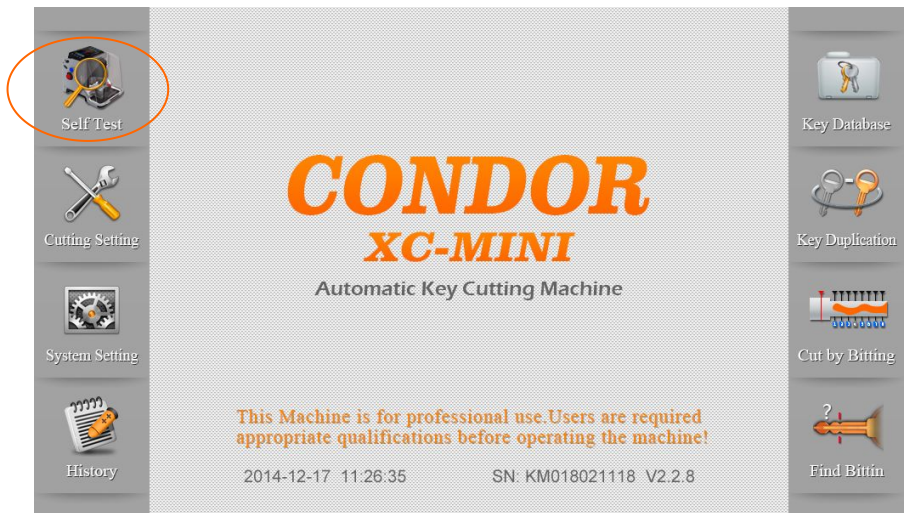

- 1) Enter the Main interface, Click on Self Test

List of Parameter

PD		M1		M2		M3	
PDX	24.00	Xc	-3.00	Xc	-18.00	Xc	-24.50
PDY	0.00	Yc	-2.00	Yc	-7.00	Yc	-6.00
PDZ	-0.12	Xco	-10.00	Xco	0.00	Xcob	-8.00
DMoff	0.00	Yco	-36.00	Yco	-32.00	Ycob	-31.00

2) Enter Self Test interface, Click on Cutting Calibration

Cutting Calibration

Reminder:

1. This function can cut a blank key, mainly for Calibration.
2. Before accessing this function, please confirm that the "Height Level Adjustment of Cutter" is completed.
3. Install and fasten Clamp M1
4. Clamp a blank key HON66 on the Clamp M1, then line the key up with the first location jaw, and fasten.

Please click on "Continue", and process the corresponding operations.

3) Follow the steps on the screen, then click on CONTINUE, The Cutting Calibration in Process

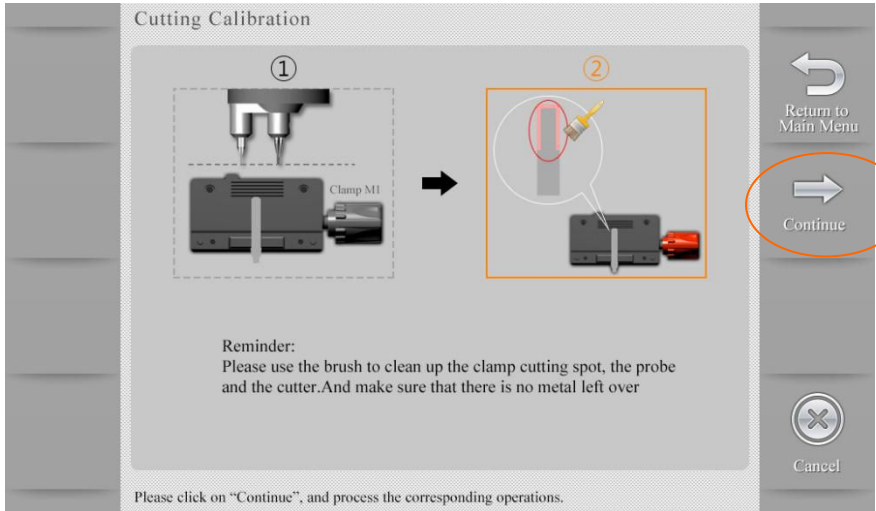

- 4) Please use the brush to clean up the clamp cutting spot, the probe and the cutter. then click on CONTINUE, Cutter Calibration Complete

6.4 How to use "Key Database"

User need to supply the key code, then can cutting the key.



1) Enter the Main interface, Click on Key Database

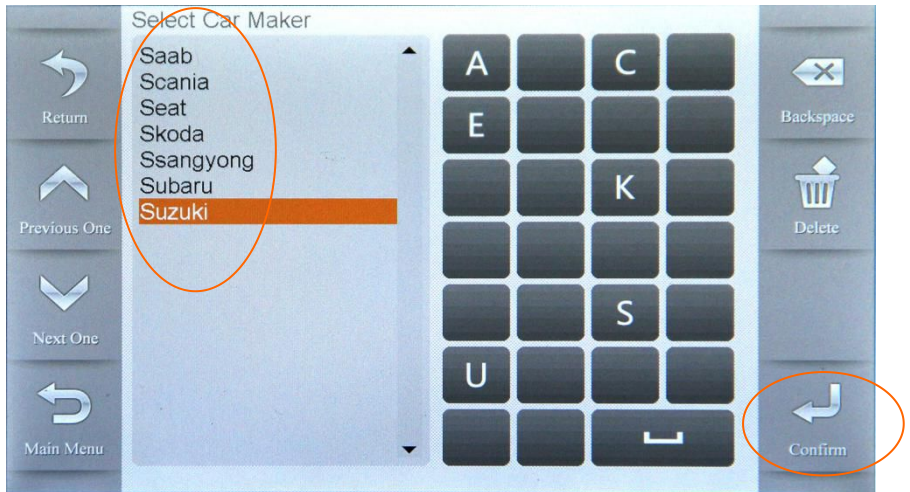

2) Choose the Car Brand, Click on Confirm

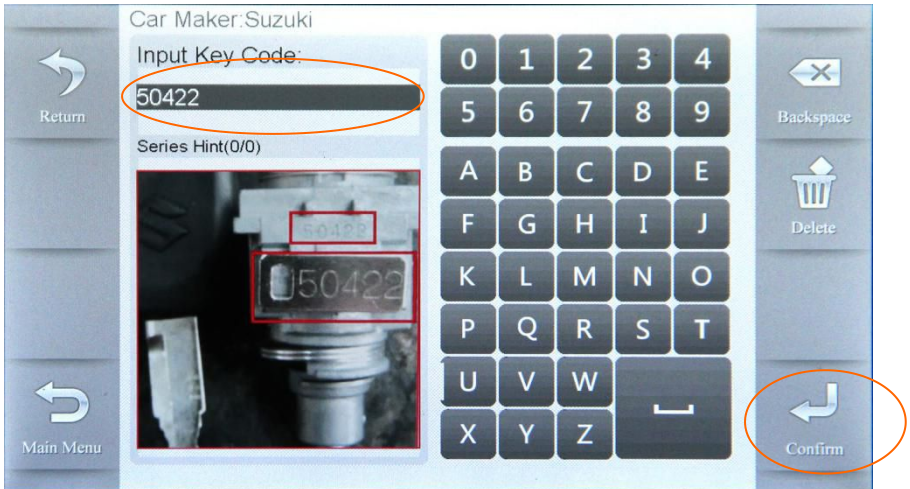

3) ① Enter the key code ② Click on Confirm

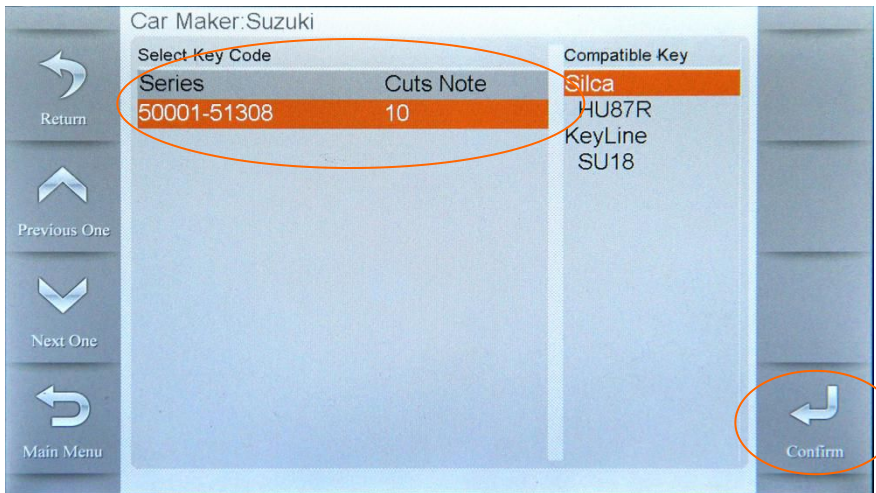

4) ① Enter the key serial code ② Click on Confirm

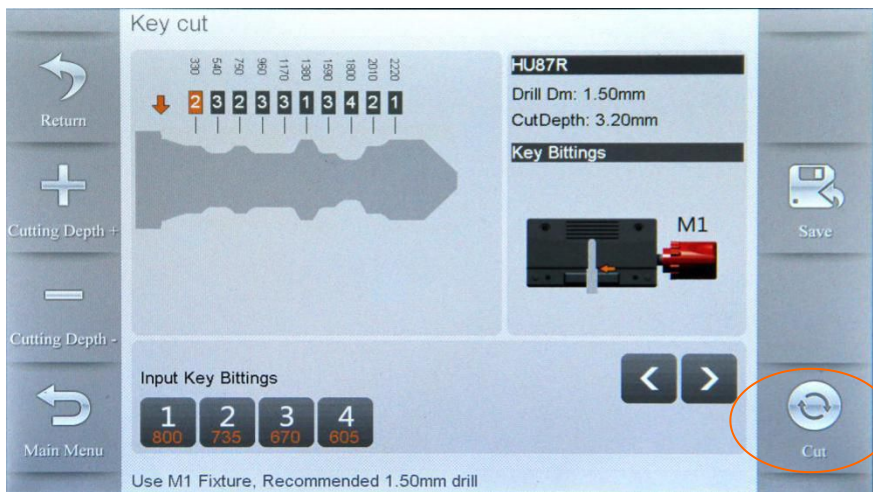

5) The Bitting Code will be found in the database, and it will be shown on the screen, Click on Cut to start

6.5 How to use “Key Duplication”

User need to supply the Car type and Year of the production

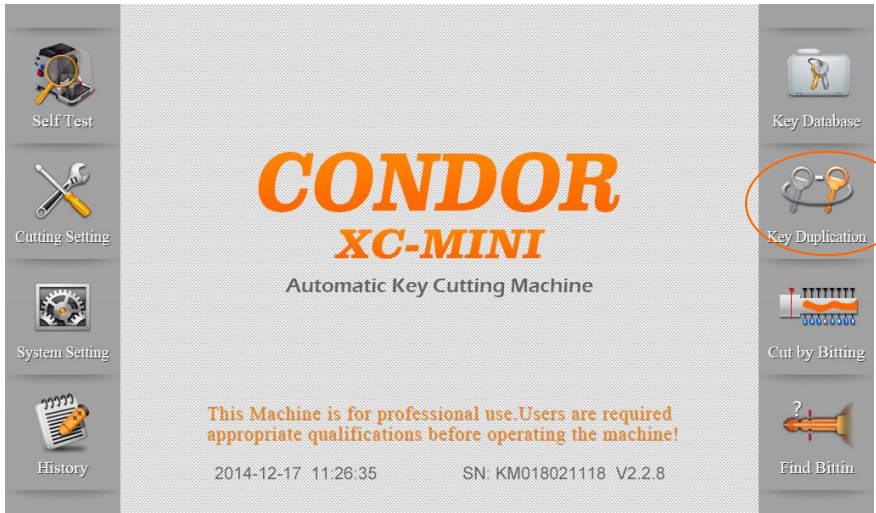

1) Enter the Main interface, Click on Key Duplication

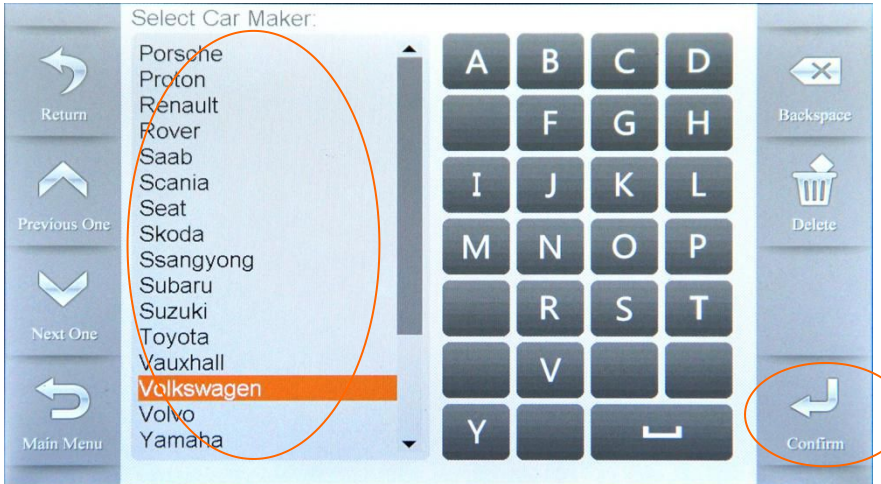

2) ① Choose the Car Maker ②Click on Confirm

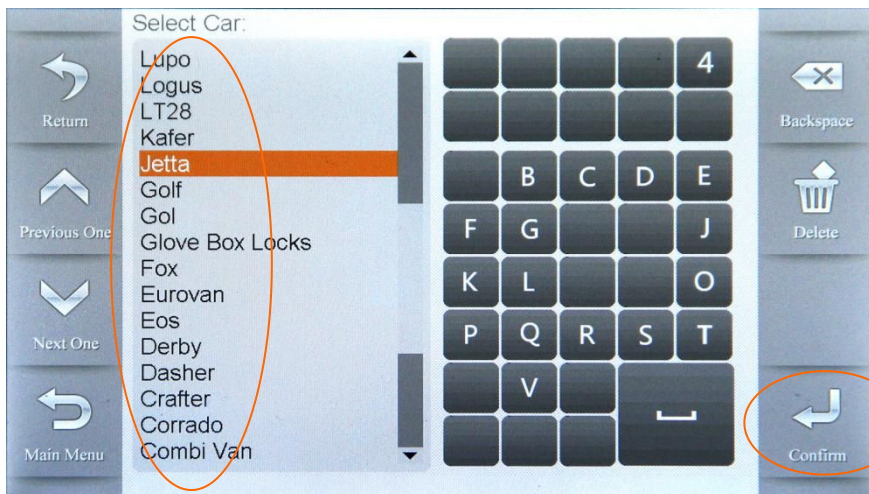

3) Choose Car Type, Click on Confirm

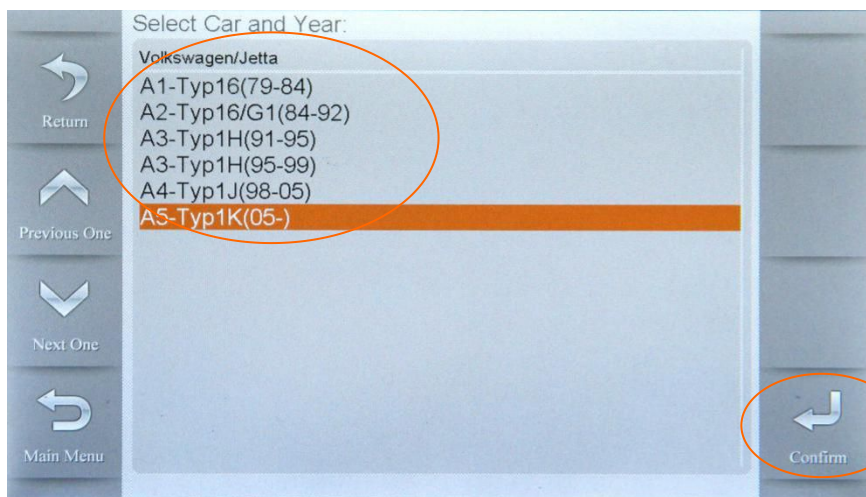

4) Choose the Car type and Year of the production, Click on Confirm

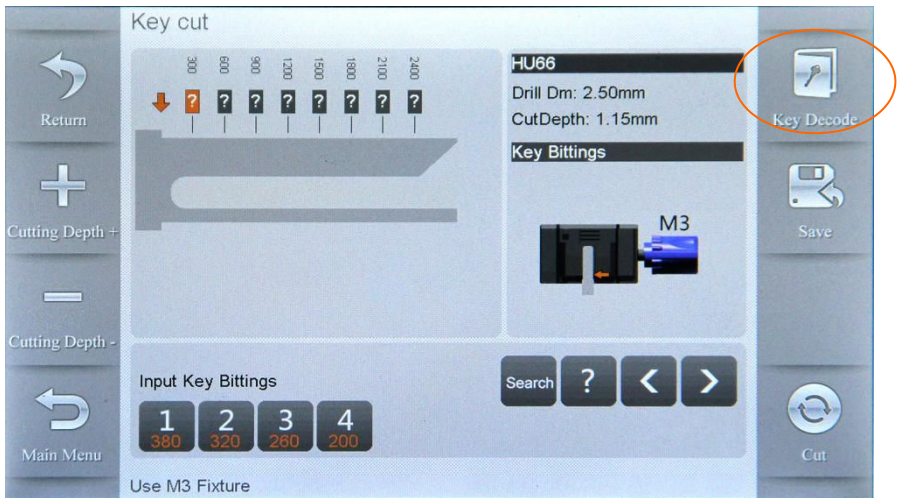

- 5) Put the original Key in the properly position of the clamp display on the screen, then Click on Decode Key

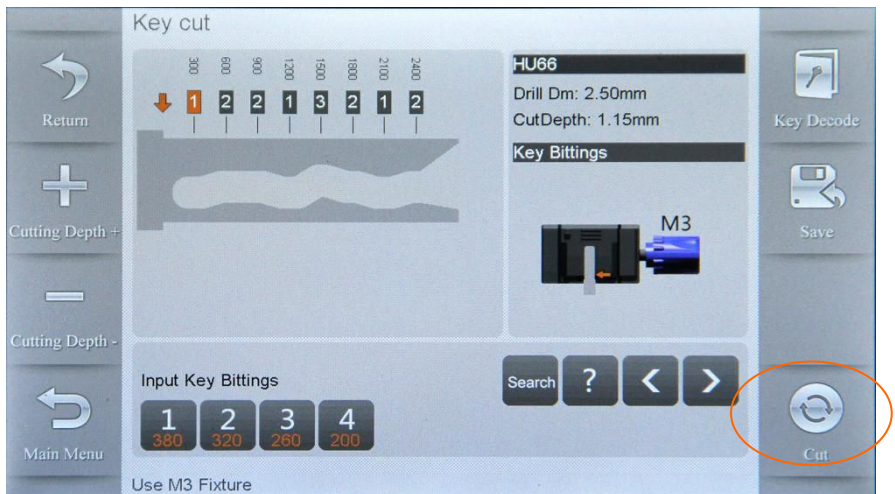

- 6) Verify bit code and modify bit code if needed, Click on Cut to start

6.6 How to use “Cut by Bitting”

There are 2 methods to get the key using Cut by Bitting

Method 1: without the origin key using Cut by Bitting

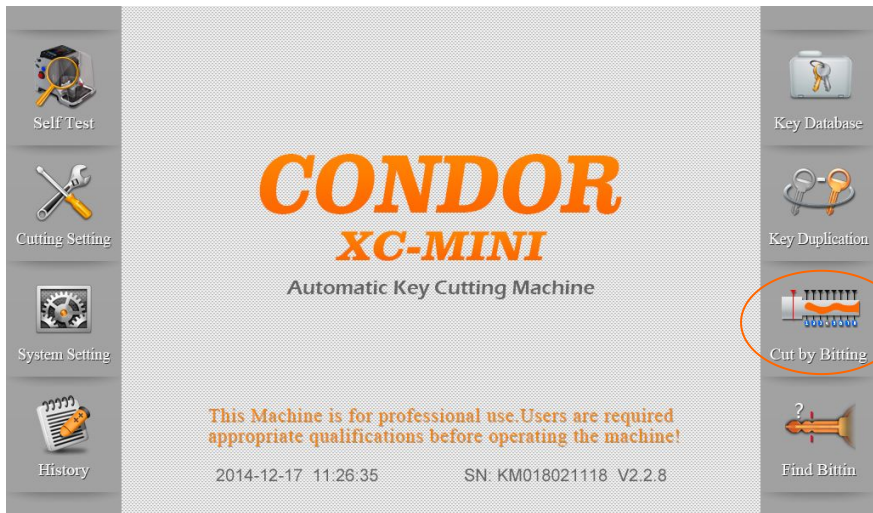

1) Enter the Main interface, Click on Cut by Bitting

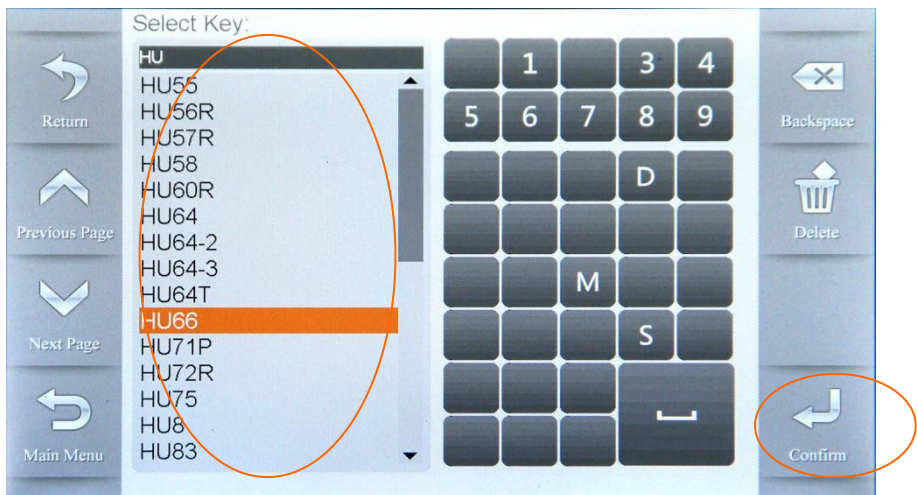

2) Choose the Blank Key, Click on Confirm

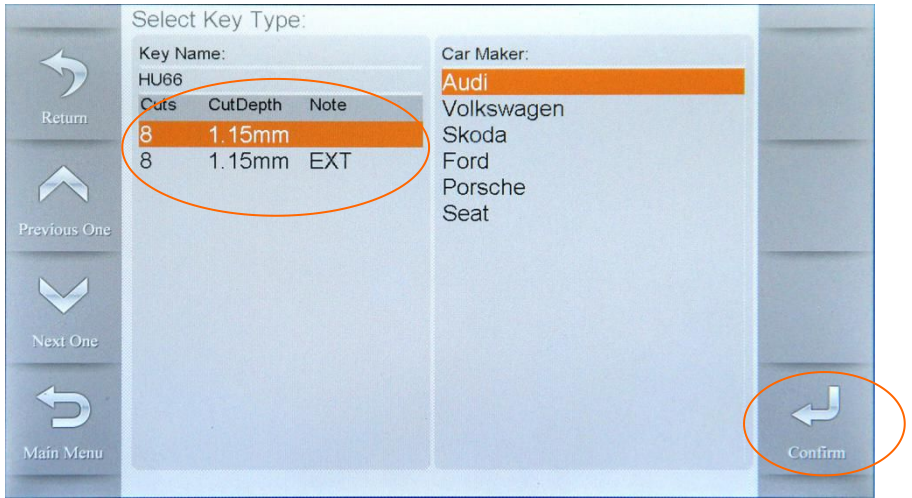

3) ① Select Key Type ② Click on Confirm

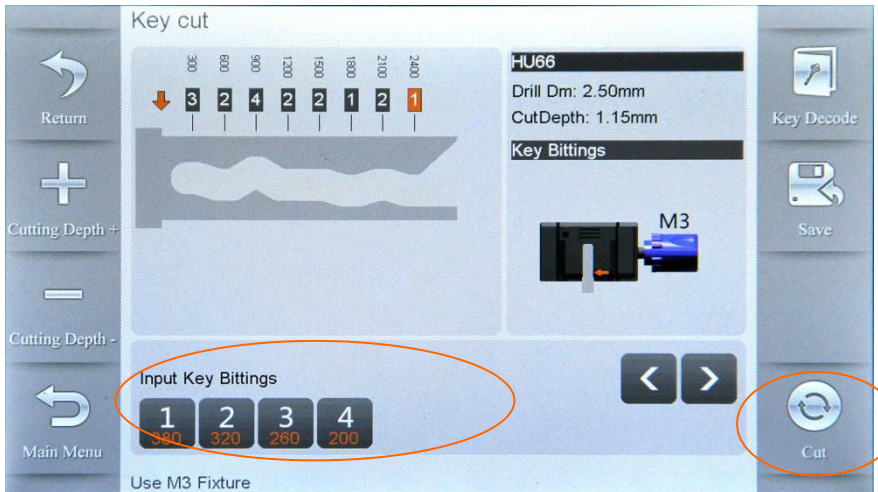

4) ① Put the Blank Key in the properly position of the clamp display on the screen
② Enter bitting and verify, then click on Cut to start

Method 2: existing the origin key using Cut by Bitting

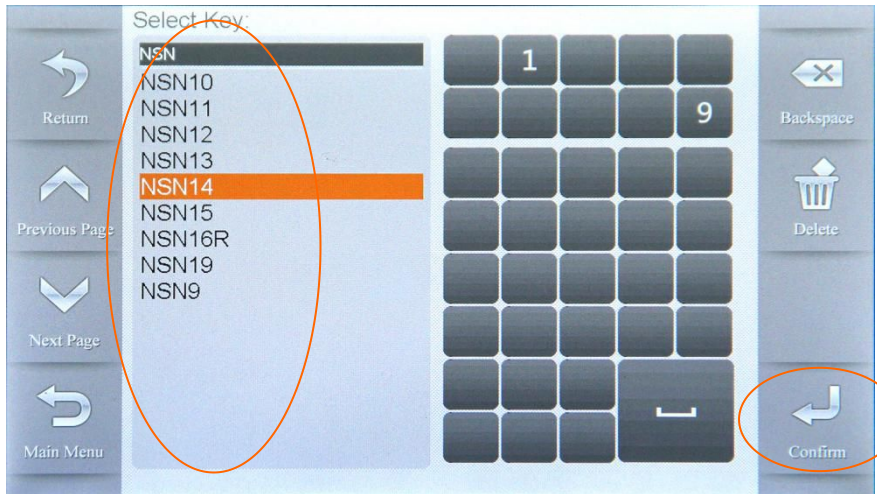

1) Choose the Blank Key, Click on Confirm

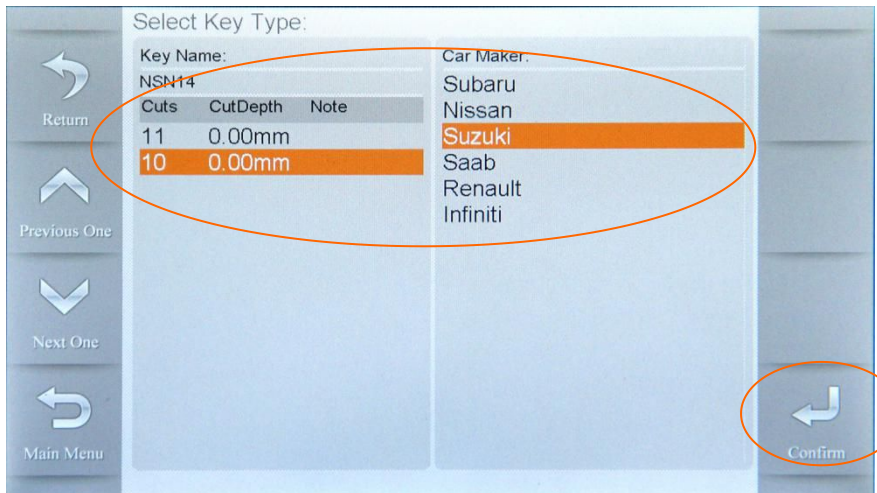

2) Select Key Type, Click on Confirm

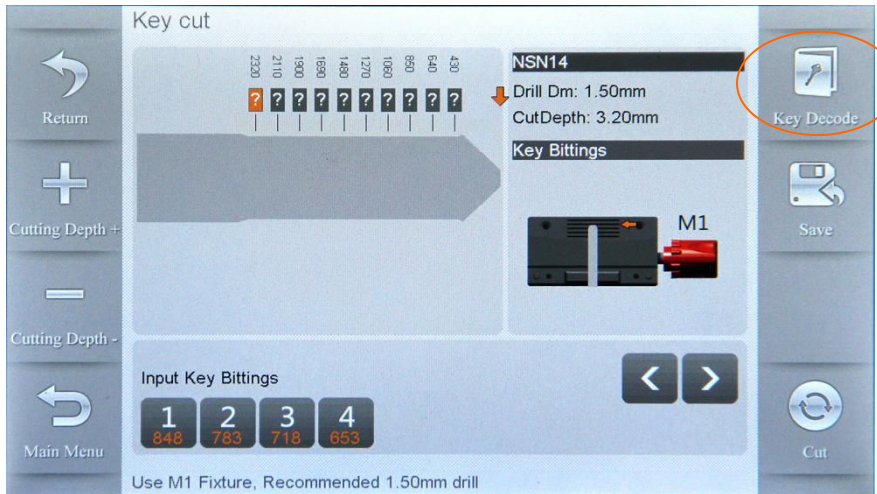

3) Click on Decode Key, the found bitting will display on the screen

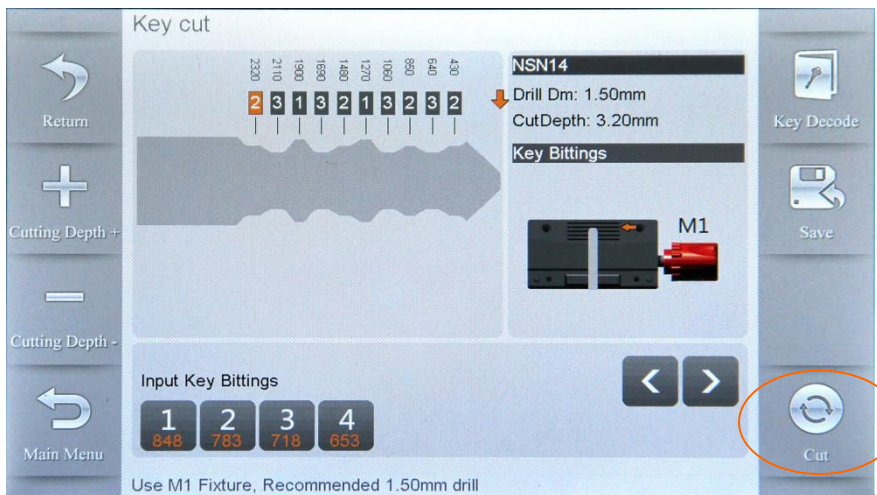

4) Verify bitting and modify bitting if needed, Click on Cut to start

6.7 How to use "Find Bitting"

Parts of the car are missing bitting on door lock/trunk lock/ignition lock, enter unknown bitting as "?"

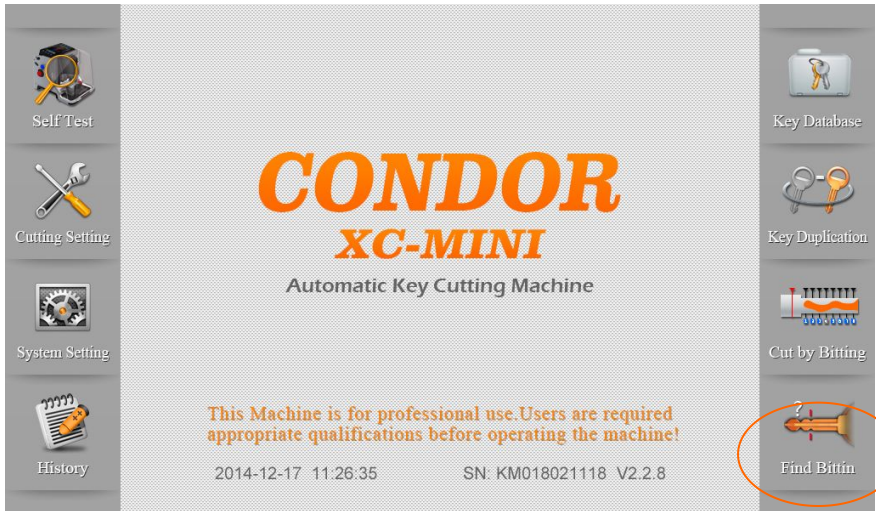

1) Enter the Main interface, Click on Find Bitting

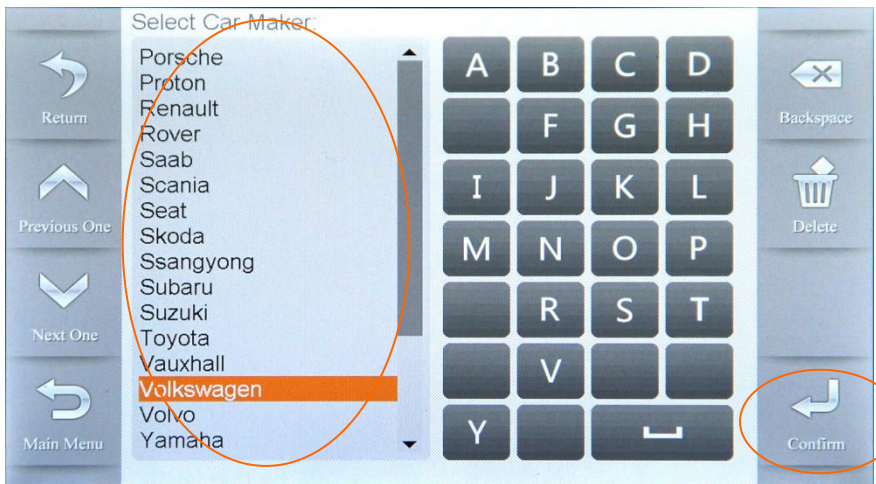

2) ① Select Car Maker ② Click on Confirm

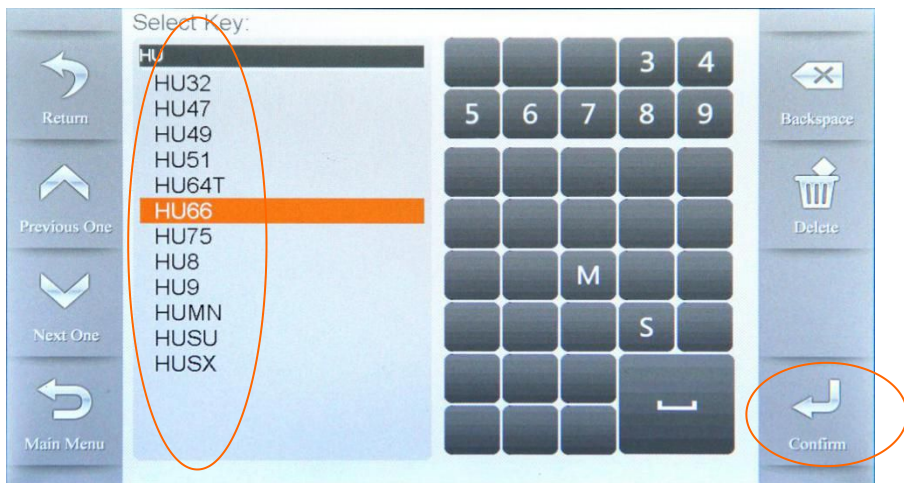

3) ①Select the Blank Key ② Click on Confirm

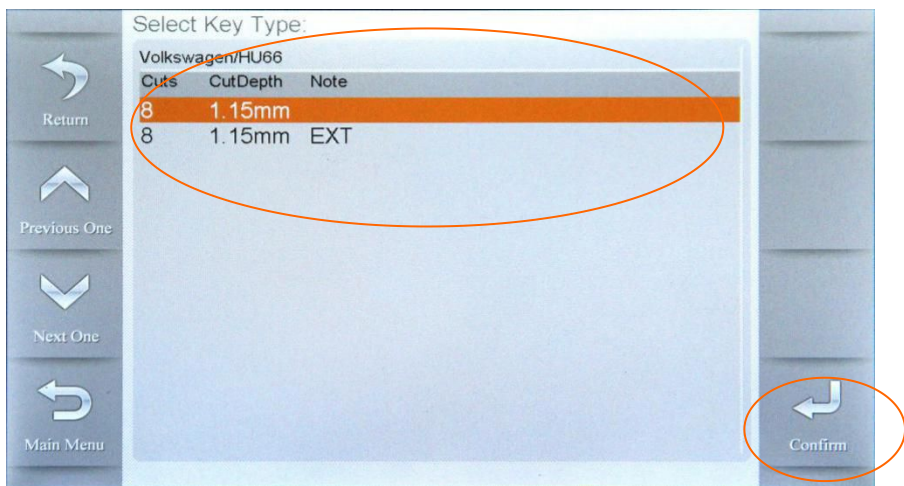

4)①Select Key Type ②Click on Confirm

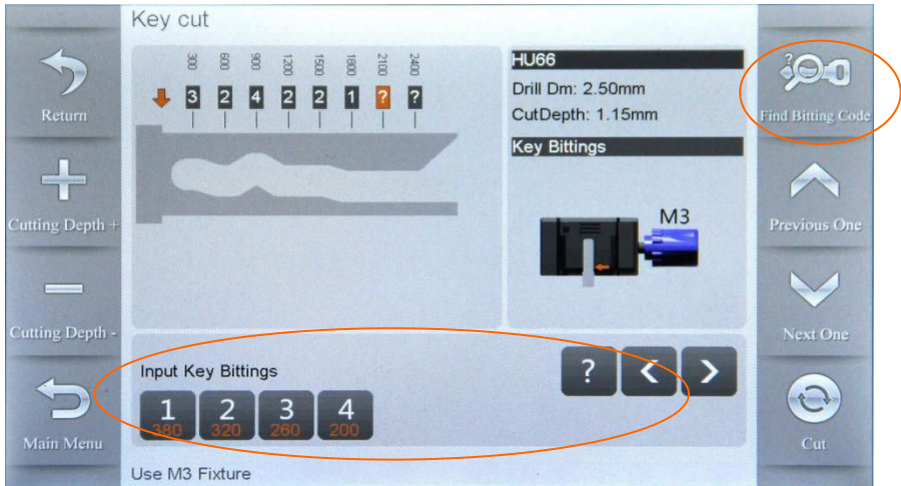

- 5) ①. Enter known bitting
- ②. Enter unknown bitting as "?"
- ③. Click on Find Bitting Code

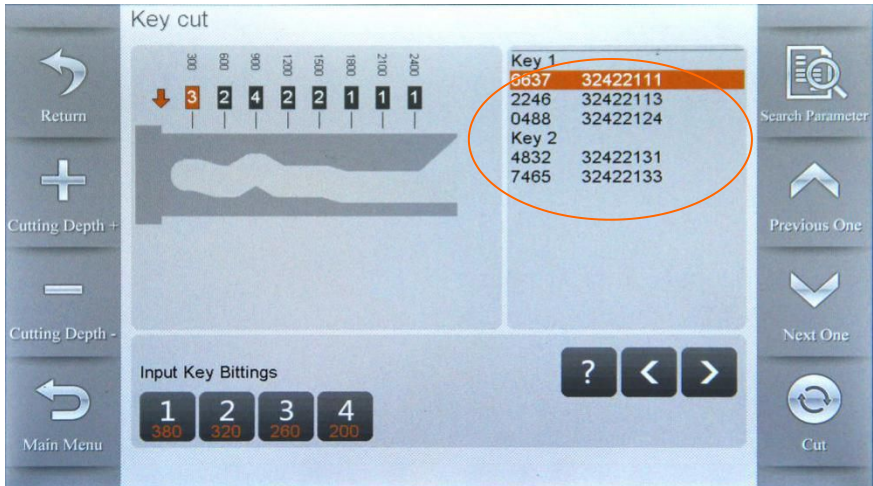

6) Possible key bitting will be listed. Note that system has sorted the codes by the most economical way in order to save blank keys. For example, the bitting under "First key" only needs three blank keys, the bitting under "Second Key" need another three blank keys, then the "third Key"...

7 . ONLINE UPDATE

Please contact your dealer/technical support for the latest Update Tool.



CONDOR XC-Mini Online Update Tool V2.0.2.exe

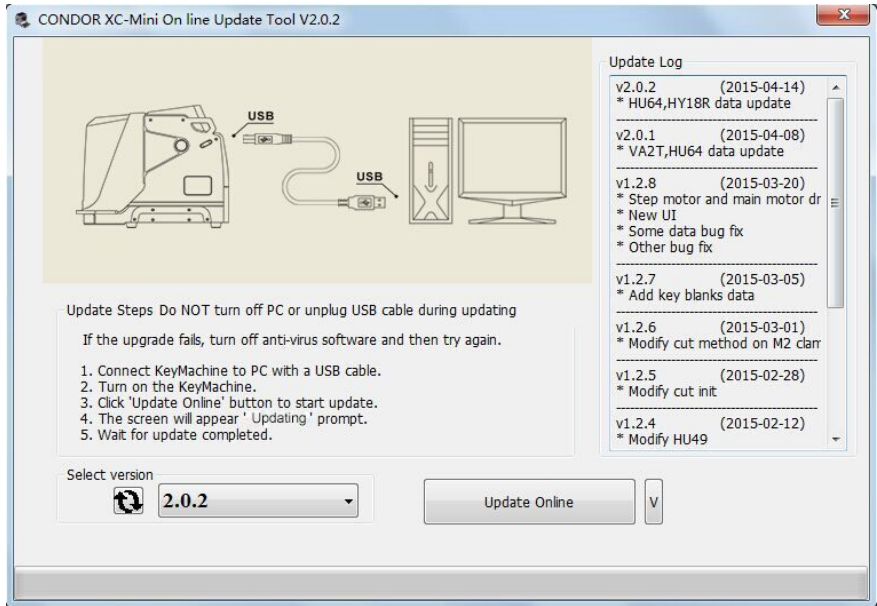

Follow the update steps those are prompted by the software

Notes:

Data downloading and firmware upgrading may take a while, please be patient.